

Standard T8 LED TUBE SPEC L05G-H (Ultra Bright)

160LM/W High Efficiency



26MM DIAMETER



180 DEG ROTATING

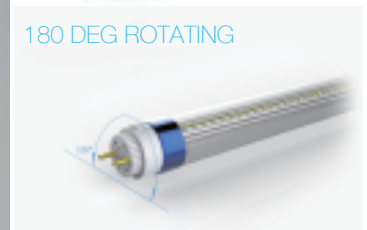



■ Matters needing attention

- Before installing the lighting fixtures, please read this instruction manual carefully.
- The lighting fixtures should be installed, connected and tested by a certified installer based on the local regulations.
- Lamps should always be installed or replaced with care.
- Please check local voltage in accordance with the product requirements before using the product.
- Relamping only can be done when the power is off and the lamp is completely cooled down.
- When a lamp is to be cleaned, make the power off and let it cool down completely. Clean the fixture with a soft cloth and a standard PH neutral detergent. Stainless steel finishing should be maintained regularly.
- Misuse of, or changes to the fixture shall nullify the guarantee.
- Don't cover the fixtures with flammable materials.
- Exclusively replaced by the manufacturer or his service agent or the similar qualified person in order to avoid a hazard.

■ S/N Rules

S/N:ABCDEFX
1 2 3 4 5 6

EX:L05GK09301100000X
1 2 3 4 5 6

- 1 Model
- 2 PC Lens : K=Frosted T=Clear
- 3 Power : 9=9W 11=11W 15=15W 18=18W 22=22W 24=24W
- 4 Color Range : 30=WW(3000K) 40=NW(4000K) 50=DW(5000K)
65=CW(6500K)
- 5 Date : 11=2011 Year 03=March
- 6 Quantity : 00001-99999PCS

■ Temperature Characteristics T-ambient 25°C

Temperature

Operating -20~+40 ℃
 Storage -40~+85 ℃

Humidity

Operating 10%-80%
 Storage 10%-80%

■ Electrical Characteristics

Input Voltage: AC220~240V 50/60Hz
 PF: ≥0.95 THD<20%
 Power Efficiency: ≥0.90



1. Features

- Patented 180Deg rotating end cap design for the best lighting result
- Just replace starter with Ervan LED fuse for retrofit
- Single end power anti electric shock ensures safety
- Maximum efficacy and minimum glare
- High-tech optical design
- TUV/SAA certification

2. Application

COMMERCIAL LIGHTING	PUBLIC LIGHTING	INDUSTRIAL LIGHTING
Office	Tunnel	Factory/Warehouse
Supermarket	MTR station Etc	Etc
Hotel	Train station	
Exhibition hall	Bus station	
Etc	Airport	
	Etc	

3. Product Dimension

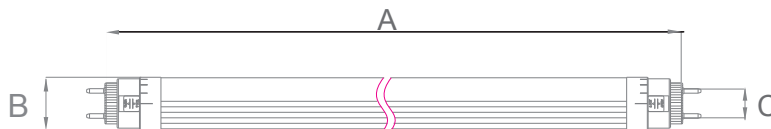

Model NO.	Size A(MM)	Size B(MM)	Size C(Base)
L05G-H/600MM	588	26	G13
L05G-H/900MM	894	26	G13
L05G-H/1200MM	1198	26	G13
L05G-H/1500MM	1498	26	G13
L05G-H/1500MM-C	1498	26	G13



4. Parameter

Model NO.	Power (W)	Light Source	LED QTY (pcs)	CCT (K)	Frosted Cover Lumens	Clear Cover Lumens	Frosted Cover Lm/W	Clear Cover Lm/W	CRI	Beam Angle
L05G-H/600MM	11	2835	56	4000K	1650	1760	150	160	>80	120°
L05G-H/900MM	17	2835	84	4000K	2550	2720	150	160	>80	120°
L05G-H/1200MM	20	2835	112	4000K	3000	3200	150	160	>80	120°
L05G-H/1500MM	24	2835	168	4000K	3600	3840	150	160	>80	120°
L05G-H/1500MM-C	30	2835	196	4000K	4500	4800	150	160	>80	120°

CCT Range WW(3000K) NW(4000K) DW(5000K) CW(6500K)

5. Installation

1. Installation For Magnetic Ballast

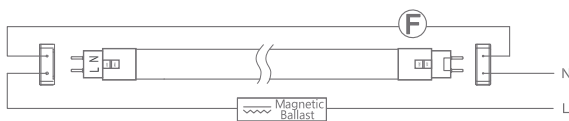

ATTENTION just replace starter with fuse for retrofit only suitable for battens with magnetic ballast , not electronic ballast

2. Installation For Electronic Ballast

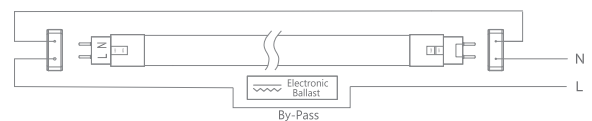

ATTENTION Electronic ballast must be by-passed by a registered electrician



1. Turn off the power

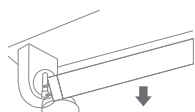

2. Take out the fluorescent tube

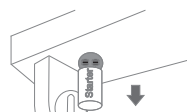

3. Take out the starter tube

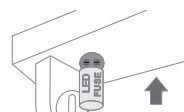

4. Install LED fuse

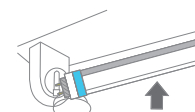

5. Install LED tube



6. Turn on the power



6.Packaging

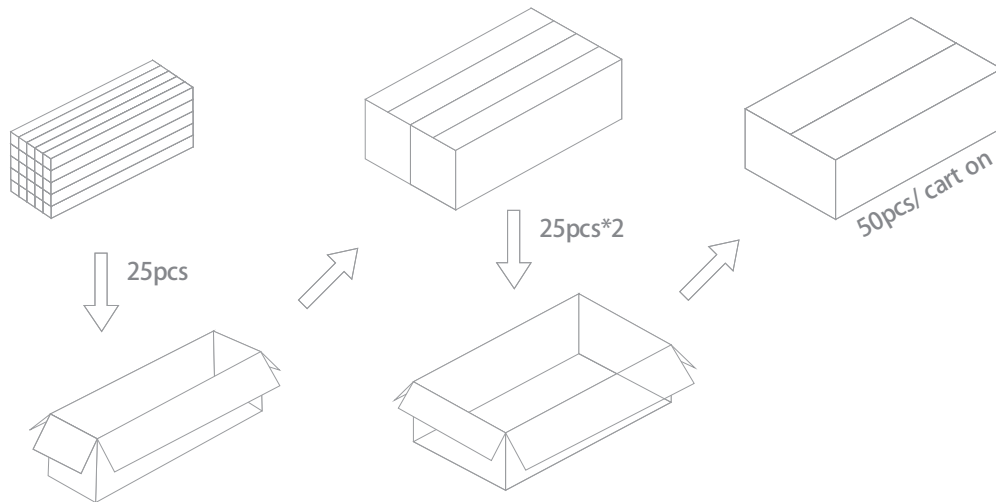

T8 Length	Type	Single Box	Pcs/ctn	N.W.(g)	G.W./ctn(kg)	Meas(cm)
600MM	TUBE (Add Fuse)	1	50	154.65	13.34	74*48*27
900MM	TUBE (Add Fuse)	1	50	216.5	18.47	105*48*27
1200MM	TUBE (Add Fuse)	1	50	270.85	22.89	135*48*27
1500MM	TUBE (Add Fuse)	1	50	342.1	28.03	165*48*27
1500MM-C	TUBE (Add Fuse)	1	50	342.1	28.03	165*48*27

7.Attention

This specification is for reference only,we reserve the right to change without notice.If you need the updated info,please contact local distributors or visit our website at <http://www.ervan.cn>